

*Lane*

**ZOOLOGY & ORNITHOLOGY**

**SPECIMEN CABINETS**



The Lane Zoology & Ornithology specimen cabinets are designed for the proper and permanent protective storage of bird and animal skins.



**PERMANENT SPECIMEN PROTECTION**

*Lane*

SCIENCE EQUIPMENT CORP.

**MODEL 201 FOR LARGE SKINS**

The 201 Model for large skins is designed for the use of large specimen trays.

Dimensions  
 Height 42 1/16"  
 Width 46 1/2"  
 Depth 28 1/32"

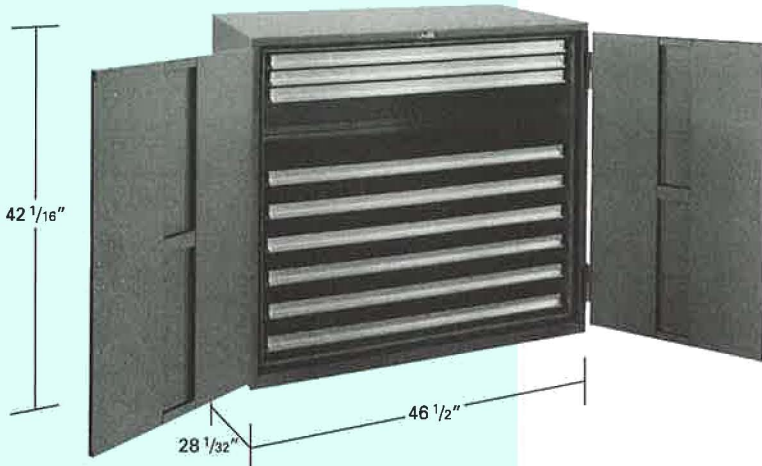

**LARGE SIZE TRAY—HIGH RIM**  
**#201-T (MASONITE/ALUMINUM)**  
**#201-T/S (STEEL)**  
 Height 3 1/2"  
 Width 42 3/8"  
 Depth 26"  
 9 Tray Maximum Capacity



**LARGE SIZE TRAY—LOW RIM**  
**#201 1/2-T (MASONITE/ALUMINUM)**  
**#201 1/2-T/S (STEEL)**  
 Height 1 5/8"  
 Width 42 3/8"  
 Depth 26"  
 18 Tray Maximum Capacity

**MODEL 202 FOR SMALL SKINS**

The 202 Model for small skins is engineered for the use of smaller trays, divided by a center conversion section. The overall size is the same as Model #201.

Dimensions  
 Height 42 1/16"  
 Width 46 1/2"  
 Depth 28 1/32"

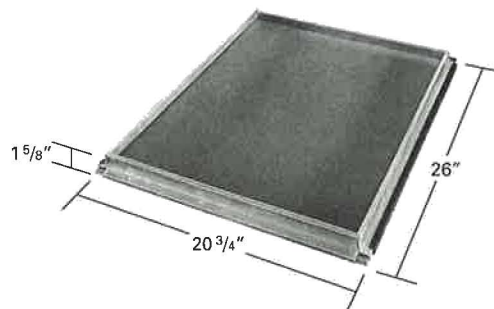
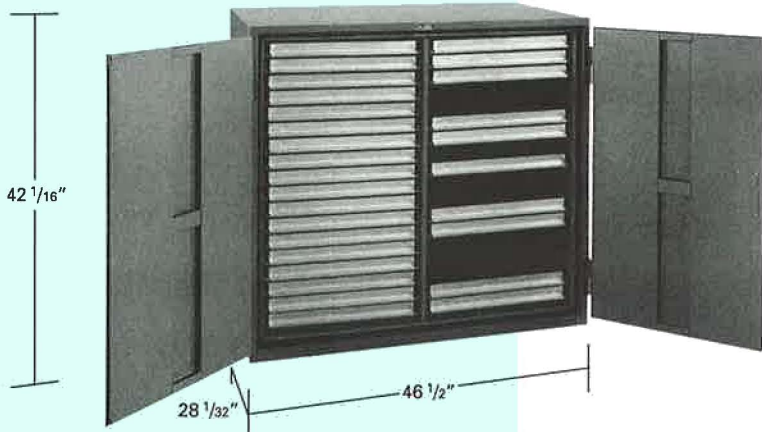

**SMALL SIZE TRAY**  
**#202-T (MASONITE/ALUMINUM)**  
**#202-T/S (STEEL)**  
 Height 1 5/8"  
 Width 20 3/4"  
 Depth 26"  
 36 Tray Maximum Capacity  
 18 Maximum Trays in Each Section

Price of cabinets does not include trays; trays must be ordered separately.

# CONSTRUCTION FEATURES TO PROTECT YOUR COLLECTION

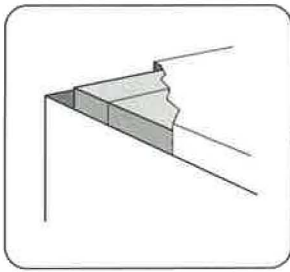

**DOUBLE WALL CONSTRUCTION**  
All welded double wall construction assures rigidity and durability.

**ELASTOMERIC DOOR SEAL**  
• No adhesives

**LIFT-OFF DOOR WITH SLIP TYPE HINGE**  
13 gauge steel, safe-type design and size permit easy removal and replacing of the door. This type of door is extremely useful when mass transference of specimens is to take place.

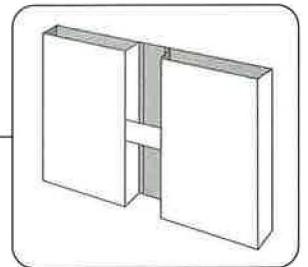
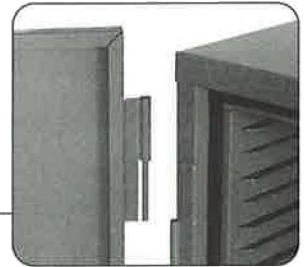

**DOUBLE PANELED DOOR**  
Assures complete and total contact with airtight seal.



**FUMIGANT COMPARTMENT**  
for convenient storage of fumigant pellets.

**CENTER CONVERSION SECTION—200CD**

A center section can be added or removed to this basic model. Large specimen trays can be inserted into the 201 model without the center conversion section. Should you desire a double case (202 model) instead of your present 201 model, simply order this section along with smaller trays and you have the Model 202. This feature affords maximum flexibility!

## MAXIMUM FLEXIBILITY

### TRAYS

- Trays are available with a natural aluminum frame and masonite bottom or, with all steel construction.
- Aluminum/masonite trays are light weight, yet rigid and are unpainted.
- Steel trays are rigid and have powder paint finish.

All trays feature:

- Plastic runners with rigid polystyrene edges
- Built in label holder
- Ease of operation

### CABINETS

- Lane cabinets 201 and 202 skin cases can be stacked to maximize storage space.
- They can be placed in a row and used as a work counter.
- And, they can be converted from one model to the other by adding or deleting the center conversion section.

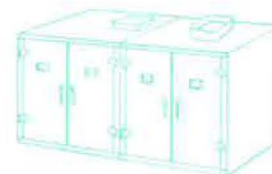

Placed in a row and used as a work counter.

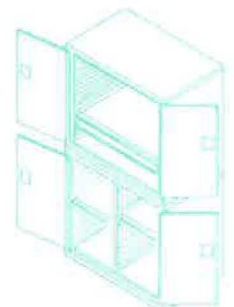

Model 201 over 202



S C I E N C E   E Q U I P M E N T   C O R P .

**OTHER LANE  
SPECIMEN CABINETS**



**HERBARIUM**

Cabinets for the storage of  
botanical specimens



**GEOLOGY & PALEONTOLOGY**

Cabinets for storage of rock and  
fossil collections



**ENTOMOLOGY**

Cabinets for pest proof, insect  
specimen storage

**PERMANENT  
SPECIMEN  
PROTECTION**

225 West 34th Street  
Suite 1412  
New York, NY 10122

212.563.0663 tel  
212.465.9440 fax  
[www.lanescience.com](http://www.lanescience.com)

**ABOUT LANE SCIENCE EQUIPMENT**

Lane Science Equipment has been a leader in the field of preservation for over fifty years. Our cabinets have been the first choice of museums, universities, and individual collectors all over the world. Customers want, and get, equipment of excellent quality and rugged construction designed for substantial use.

In addition, by providing customers with the highest quality service and rapid response time, we demonstrate our loyalty and respect for you and your collections. We understand your needs. We care about your collections and we want to show you how Lane can best serve you.

**FOR ADDITIONAL INFORMATION ON  
LANE SPECIMEN CABINETS PLEASE CONTACT:**

**Lane Science Equipment Corp.  
225 West 34th Street  
New York, NY 10122-1496  
Tel: 212-563-0663  
Fax: 212-465-9440**

**Visit our Web Page at  
[www.lanescience.com](http://www.lanescience.com)**